

# NOTICE DE MONTAGE

ASSEMBLY INSTRUCTIONS    MONTAGEANLEITUNG    MONTAGE AANWIJZINGEN    ISTRUZIONI DI MONTAGGIO    INSTRUCCIONES DE MONTAJE

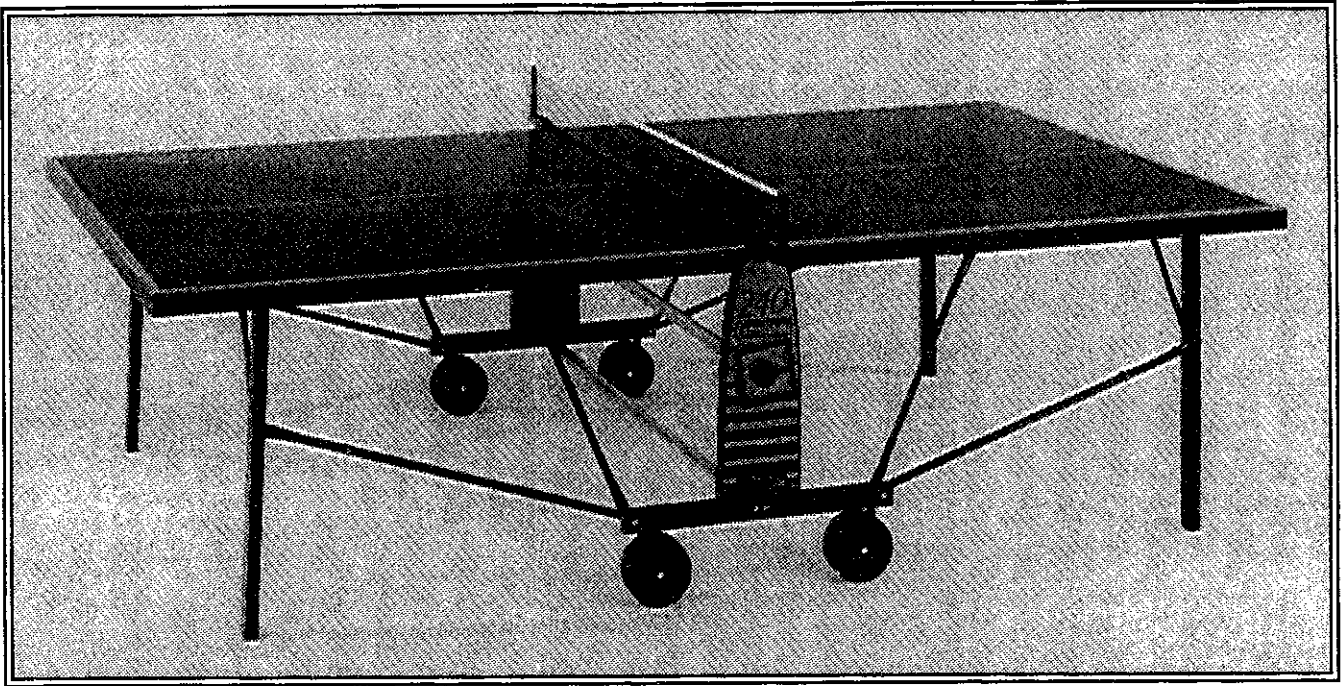

Document à conserver - Please keep for future reference - Das Dokument ist aufzubewahren - Goed bewaren - Documento da conservare - Documento a conservar

## 240 OUTDOOR

bleu   blau   azul  
blue   blu   blauw

réf:240500/03

Date de Jéré  
Fabrication  
27/03/00

vert   grün   verde  
green   verde   groen

réf:240600/03

Date de Jéré  
Fabrication  
25/04/00

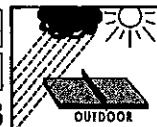

# Cornilleau

# CONTENU DU COLIS

THIS BOX CONTAINS

INHALT DES PAKETS

INHOUD VAN DE DOOS

CONTENUTO DEL CARTONE

CONTENIDO DEL PAQUETE

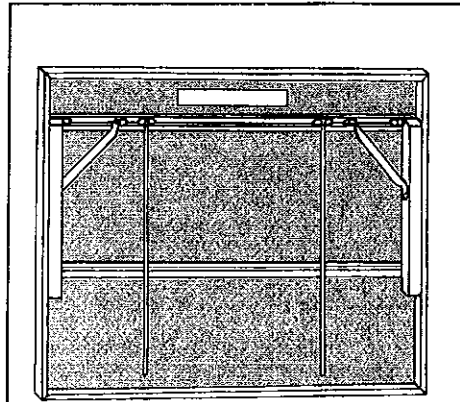

BLEU PL240500A/03 QTE:2  
VERT PL240600A/03 QTE:2

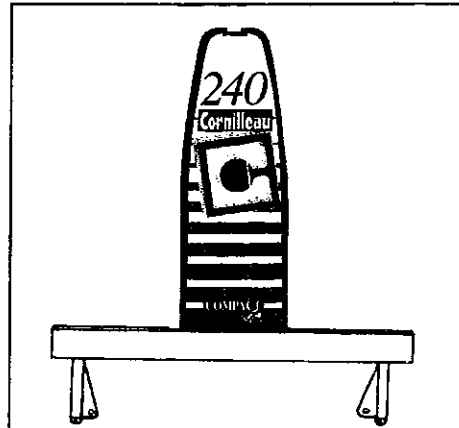

BLEU 4768.603A QTE:2  
VERT 4768.501A QTE:2

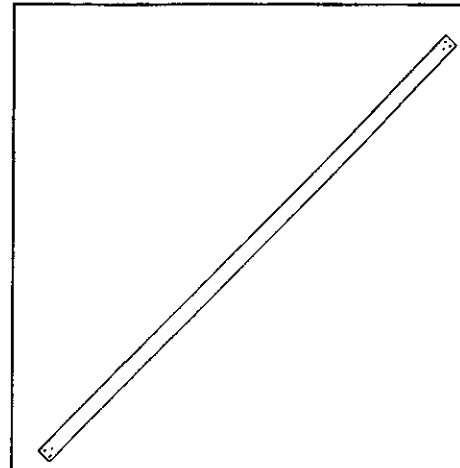

7799 QTE:2

# CONTENU DU COLIS D'ACCESSOIRES

CONTENTS OF ACCESSORIES PACK

INHALT DER ZUBEHÖR-PAKETE

INHOUD VAN DE DOOS MET SCHROEVEN

CONTENUTO DEL CARTONE DEGLI ACCESSORI

CONTENIDO DEL PAQUETE DE ACCESORIOS

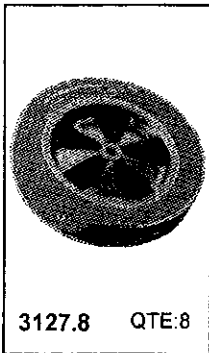

3127.8 QTE:8

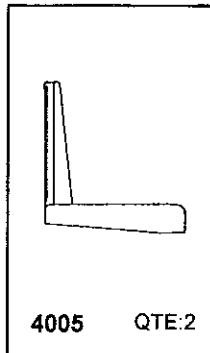

4005 QTE:2

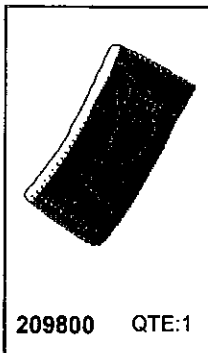

209800 QTE:1

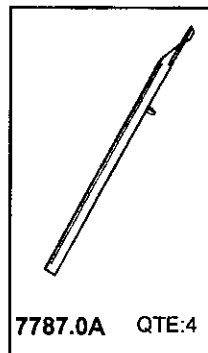

7787.0A QTE:4

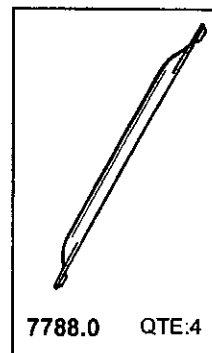

7788.0 QTE:4

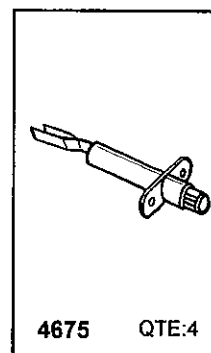

4675 QTE:4

# CONTENU DU SACHET DE VISSERIE

CONTENTS OF SCREW PACK

INHALT DES SCHRAUBENBEUTELS

INHOUD VAN HET ZAKJE MET SCHROEVEN

CONTENUTO DEL SACCHETTO DELLA VITERIA

CONTENIDO DE LA BOLSA DE TORNILLERIA

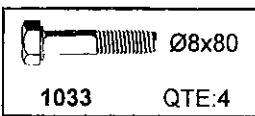

1033 QTE:4

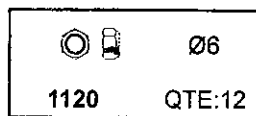

1120 QTE:12

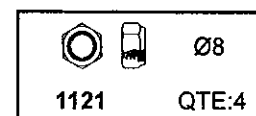

1121 QTE:4

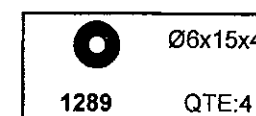

1289 QTE:4

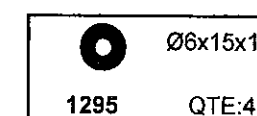

1295 QTE:4

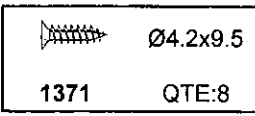

1371 QTE:8

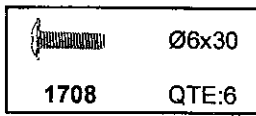

1708 QTE:6

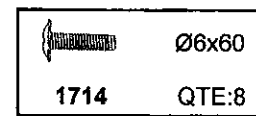

1714 QTE:8

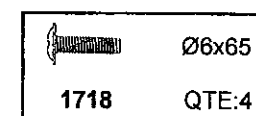

1718 QTE:4

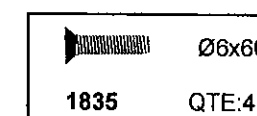

1835 QTE:4

# MONTAGE

ASSEMBLY

MONTAGE

MONTAGE

MONTAGGIO

MONTAJE

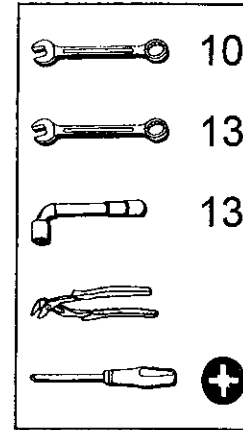

**F** Le montage doit être réalisé par 2 adultes, en respectant l'ordre des phases de montage suivant : ①, ②, ③... La visserie utilisée (type et dimensions) doit être conforme au croquis de chaque phase de montage. Les quantités indiquées permettent de répéter les opérations nécessaires pour chaque phase de montage.

**GB** The assembly should be carried out by two adults, respecting the order of the assembly steps as per : ①, ②, ③... The fasteners used (type and size) must comply with the diagram for each step of the assembly. The quantities indicated permit the operations required for each step of the assembly to be repeated.

**D** Die Montage muß von 2 Erwachsenen unter Einhaltung der Reihenfolge der Montageschritte gemäß : ①, ②, ③... usw durchgeführt werden. Das verwendete Schraubmaterial (Typ und Maße) muß der Skizze jedes Montageschritts entsprechen. Die angegebenen Mengen ermöglichen die Wiederholung der erforderlichen Operationen für jeden Montageschritt.

**NL** De montage moet worden uitgevoerd door 2 volwassenen, waarbij de volgorde van volgende montagefasen dient te worden in acht genomen : ①, ②, ③... Het gebruikte schroefwerk (type en afmetingen) dient in overeenstemming te zijn met de schets van elke montagefase. De aangegeven hoeveelheden maken het mogelijk dat de nodige bewerkingen voor iedere montagefase kunnen worden herhaald.

**I** Il montaggio deve essere effettuato da due persone adulte rispettando le fasi previste ai punti : ①, ②, ③... Le viti da usare (tipo e dimensioni) devono essere conformi al disegno su ogni fase di montaggio. La quantità indicate permettono di individuare le operazioni necessarie per ogni fase di montaggio.

**SP** El montaje debe ser realizado por dos adultos, respetando el siguiente orden de las fases de montaje : ①, ②, ③... La tornillería utilizada (tipo y dimensiones) debe ser conforme al croquis de cada de montaje. Las cantidades indicadas permiten repetir las operaciones necesarias para cada fase de montaje.

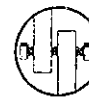

**Laisser du jeu**  
Leave a little play  
Es ist ein Spiel zu lassen

Laat wat speling  
Lasciare del gioco  
Dejar holgura



**Serrer normalement**  
Tighten  
Normal anzuziehen

Draai normaal aan  
Chiudere normalmente  
Apretar normalmente

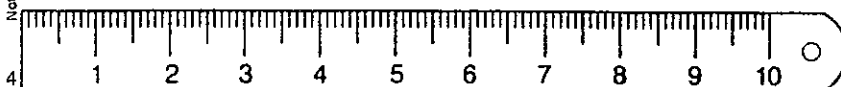
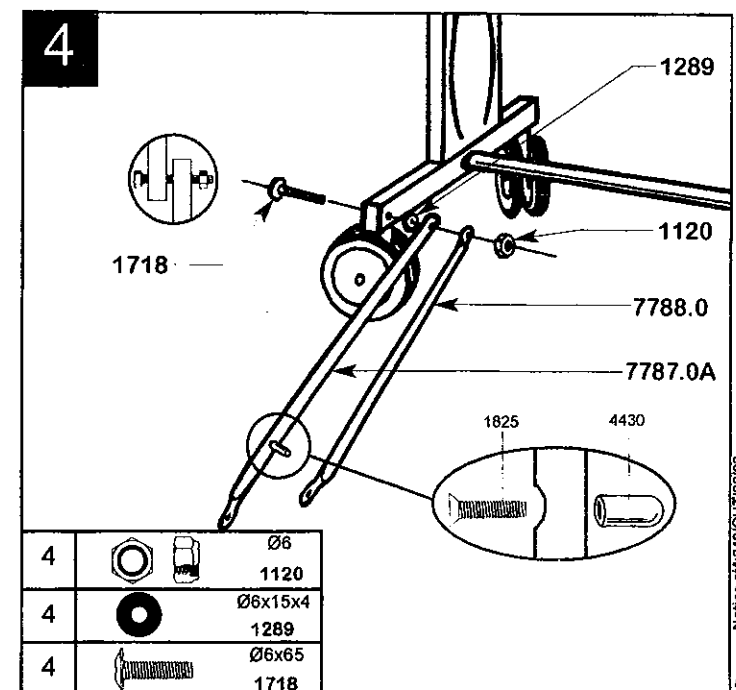
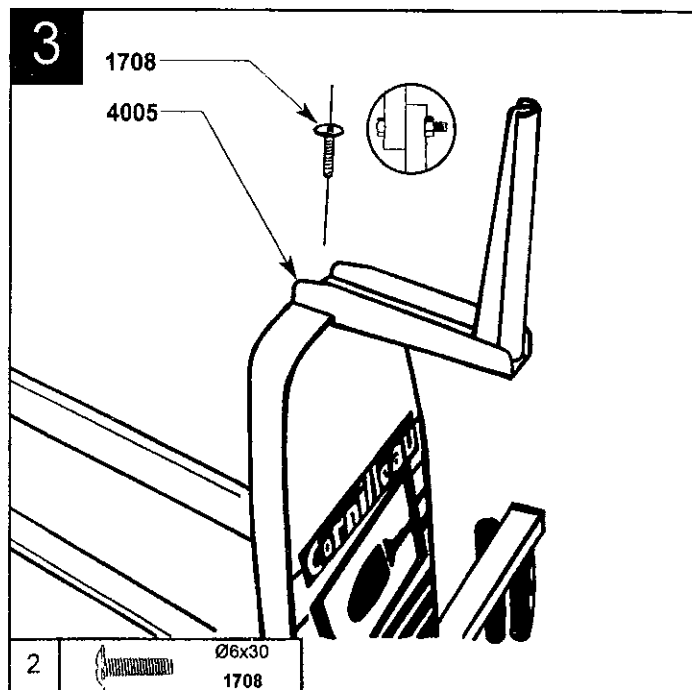
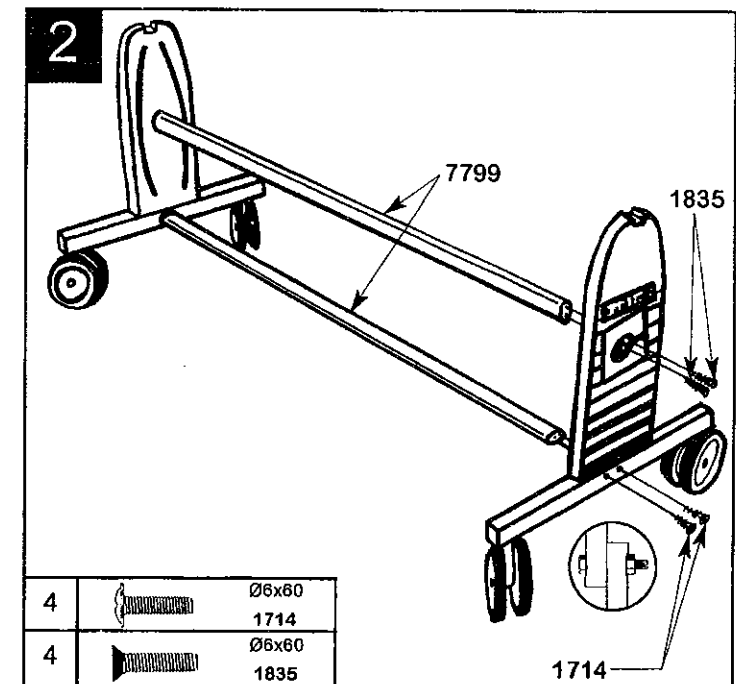
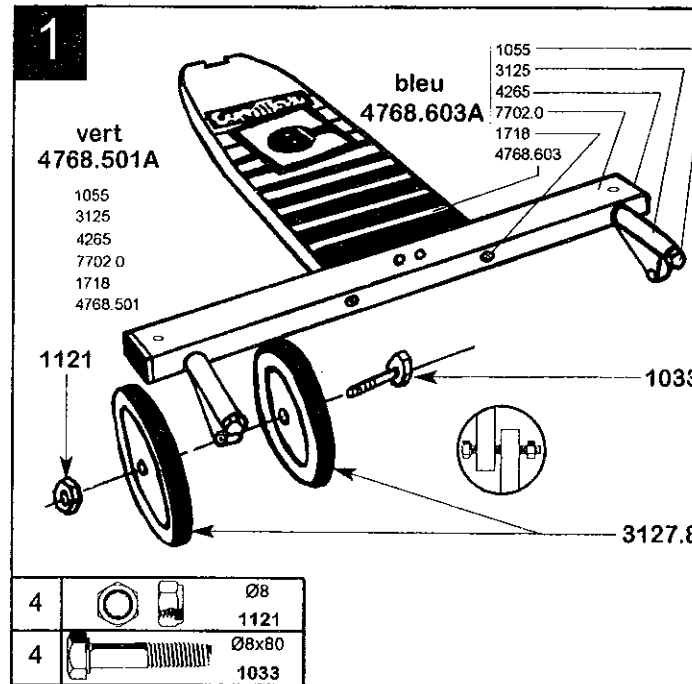

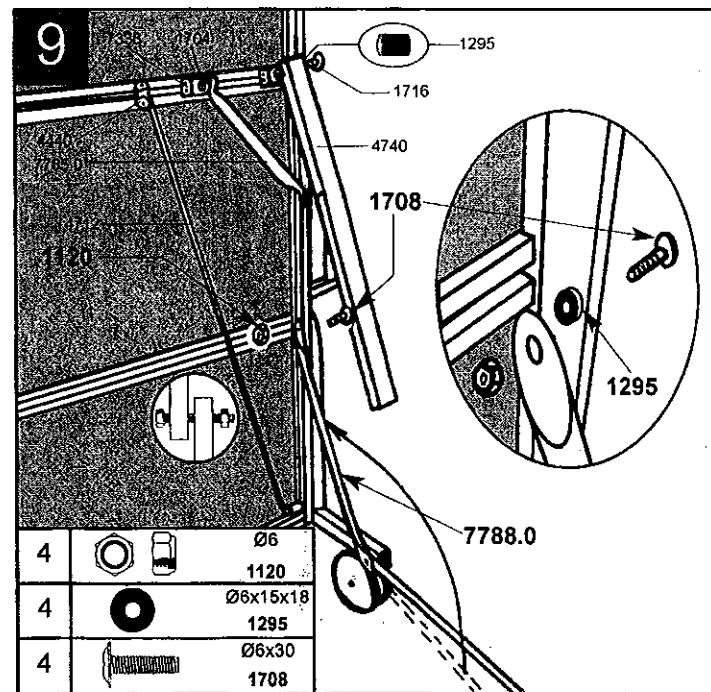
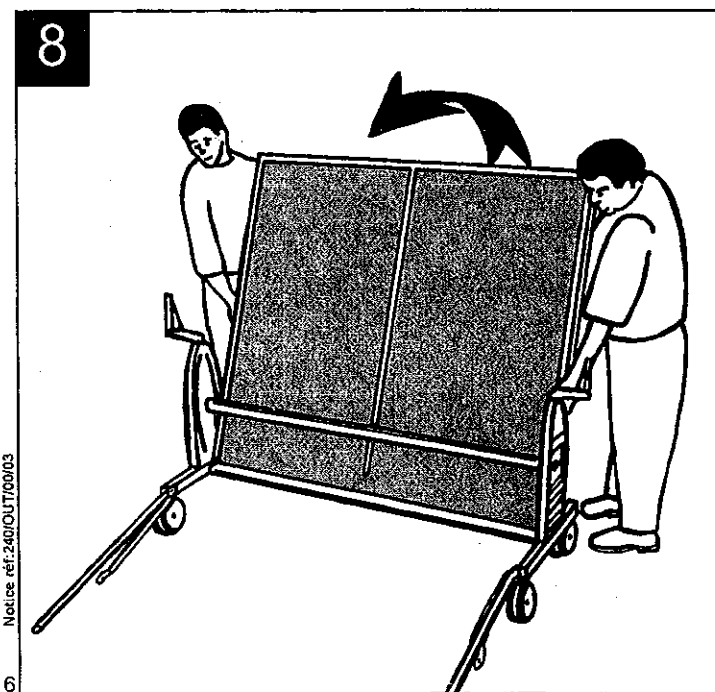
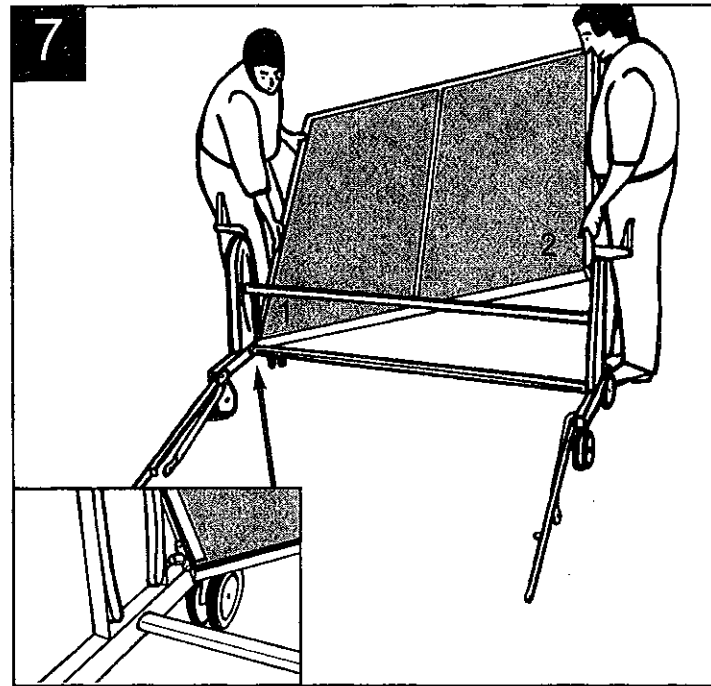
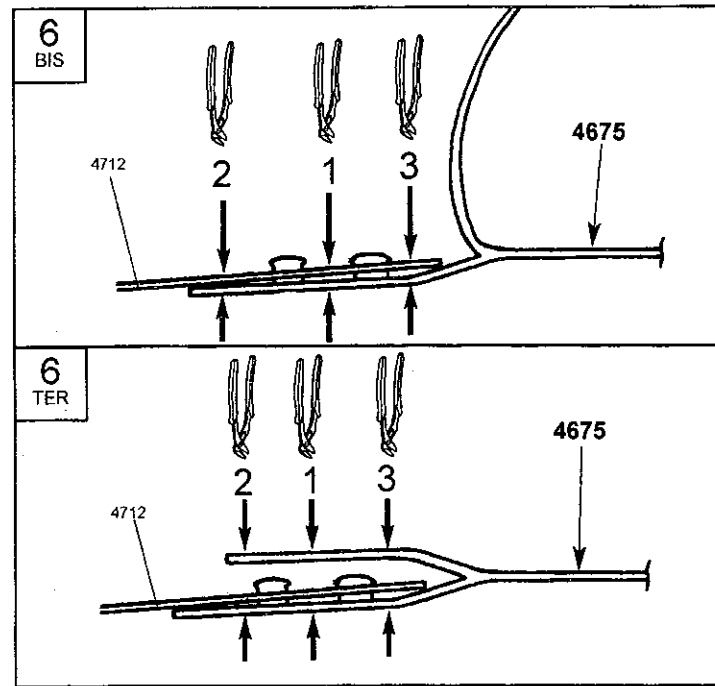
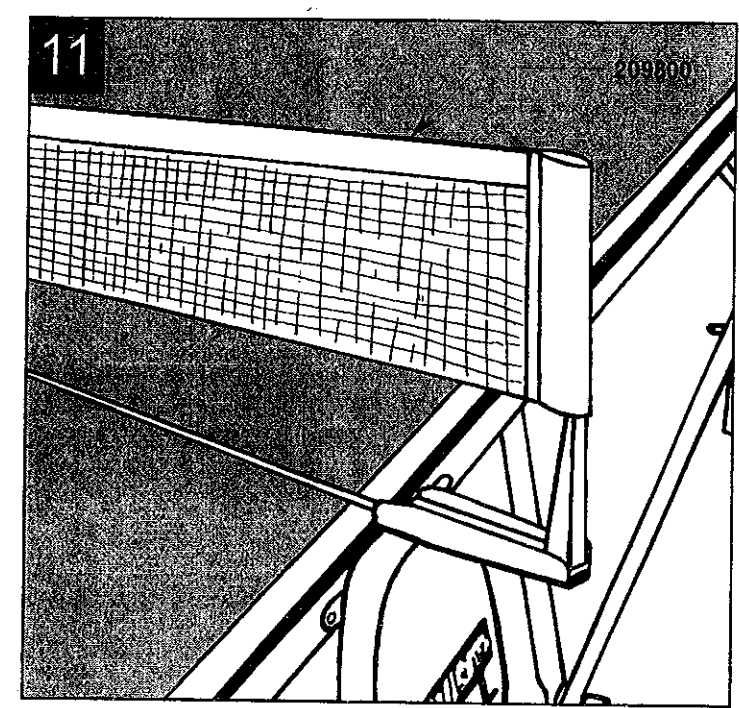
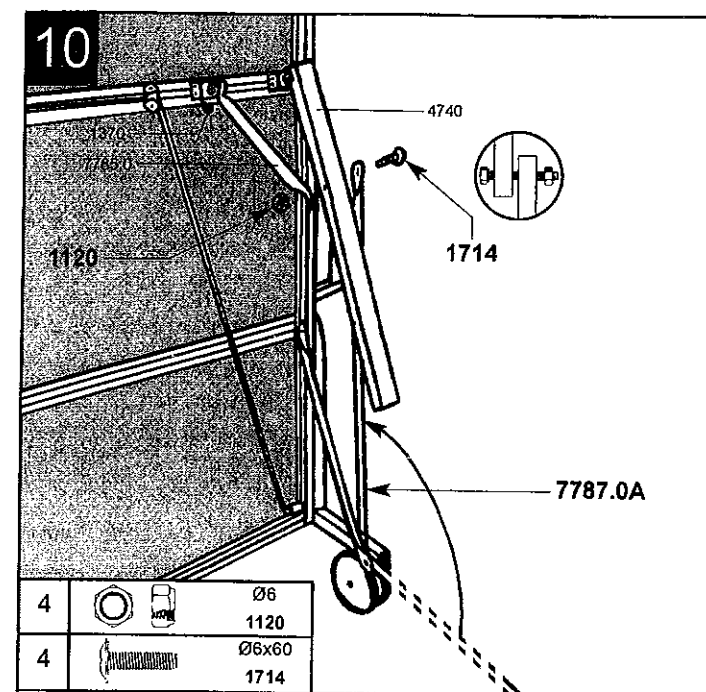
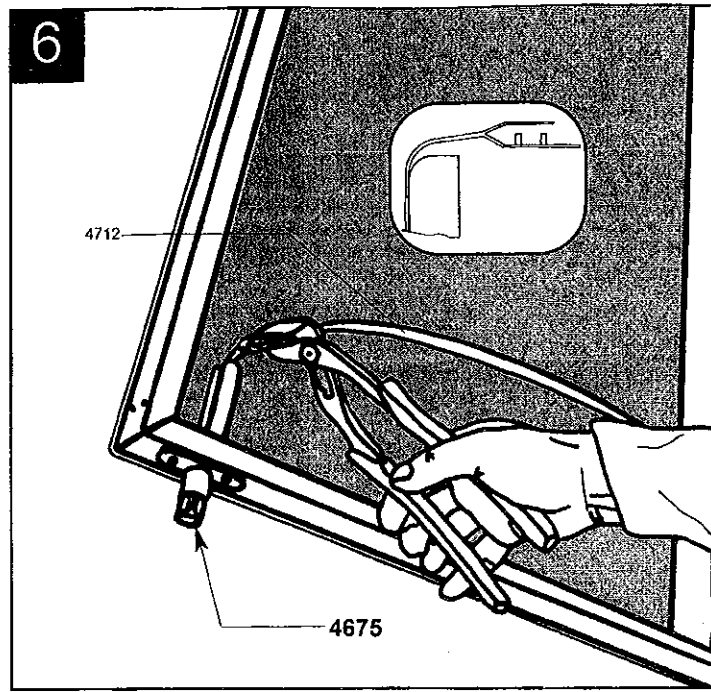
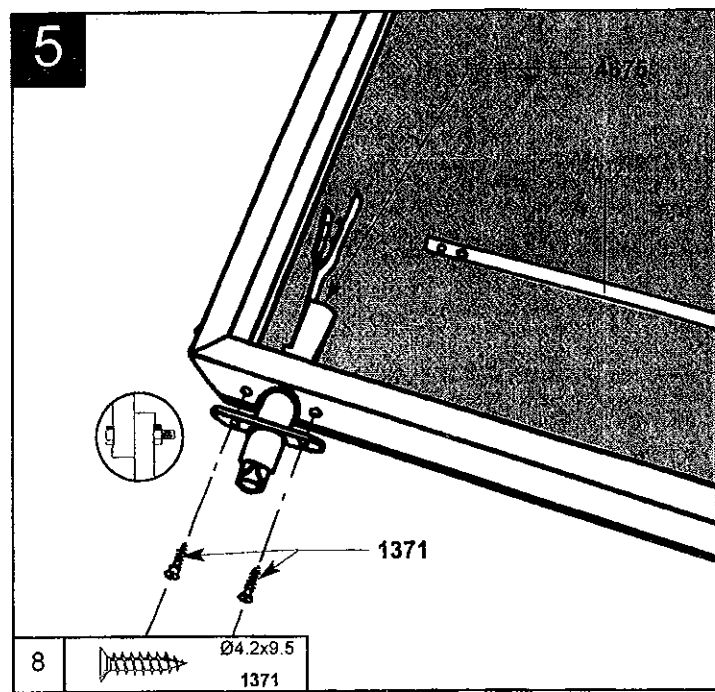

# 240 OUTDOOR

N°: \_\_\_\_\_





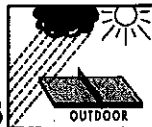





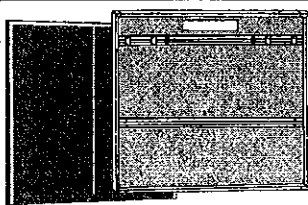

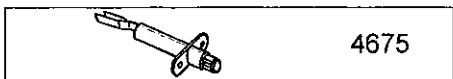

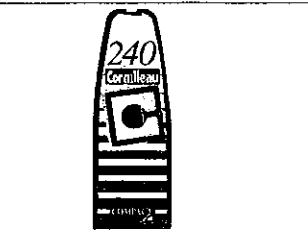

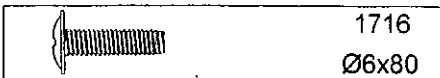
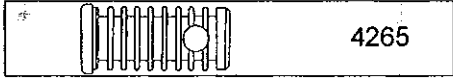

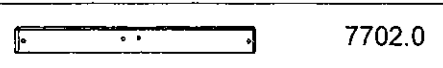
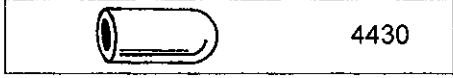



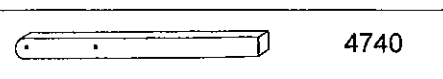

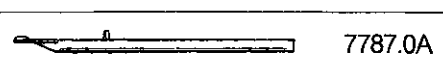
bleu blau azul  
blue blu blauw  
réf:240500/03

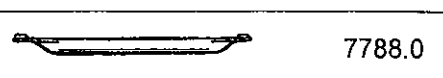
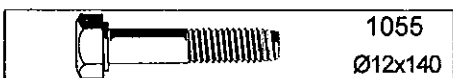
vert grün verde  
green verde groen  
réf:240600/03

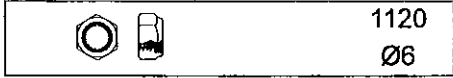
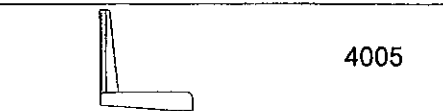

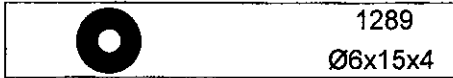
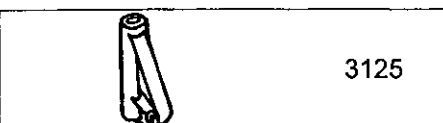
F Pour commander des pièces détachées, mentionner impérativement le type, la référence et le numéro de série se trouvant sous le plateau. (N° à compléter)  
GB When ordering spare parts, please quote the type, the reference and the serial number stamped under the top. (N° to fill in)  
D Bei der Bestellung von Einzelerersatzteilen ist es unerlässlich, die vollständigen Artikel- und Seriennummern anzugeben. Diese Nummern sind unter der Platte ersichtlich.  
NL Bestelling van reserve-onderdelen, altijd voorzien van : Artikelcode en serienummer van tafelblad. (Zie onderzijde van blad)  
I Per ordinare i pezzi di ricambio, occorre menzionare il tipo; il n. di referenza e il n. di serie che si trovano sotto il piano. (N.....)  
SP Para el tratamiento de sus pedidos de piezas de recambio, sírvase mencionar el referencia el tipo y el número de serie que se encuentra bajo el tablero. (N.....)

## NOMENCLATURE DES PIÈCES DÉTACHÉES

SPARE PARTS LIST	VERZEICHNIS DER ERSATZTEILE	LIJST VAN ONDERDELEN	NOMENCLATURA DEI PEZZI DI RICAMBIO	NOMENCLATURA DE LAS PIEZAS DE RECAMBIO
 BLEU 2P240500/03		 3127.8		 1708 Ø6x30
	VERT 2P240600/03	 4675		 1714 Ø6x60
 BLEU 4768.603		 7338		 1716 Ø6x80
	VERT 4768.501	 4265		 1718 Ø6x65
 7702.0		 4430		 1825 Ø6x25
 7799		 4712		 1835 Ø6x60
 4740		 4440		
 7787.0A		 1033 Ø8x80		
 7788.0		 1055 Ø12x140		
 7785.0		 1120 Ø6		
 4005		 1121 Ø8		
 209800		 1289 Ø6x15x4		
 3125		 1295 Ø6x15x18		
		 1370 Ø4.2x12.5		
		 1371 Ø4.2x9.5		
		 1704 Ø6x12		

# Cornilleau